

Features and Application

MIL-DTL-26482 Series 2, bayonet coupling, rear-removable crimp contact connectors were designed as an upgrade to MIL-DTL-26482 Series 1. Series 2 connectors are intermountable and interchangeable with both solder and front-release crimp Series 1. They are also identical to the inactivated MIL-DTL- 83723 Series I connectors.

Series 2 connectors are widely used on commercial, military and aerospace systems requiring general-purpose, miniature cylindrical bayonet coupling connectors.

This family of connectors is offered in 4 receptacle-mounting styles. They include narrow flange wall mounting receptacles, wide flange wall mounting receptacles, cable connecting receptacles and jam nut mounting receptacles which incorporate “O” ring seals, designed for rear panel “D” hole mounting.

Plugs are available in two designs, with and without RFI grounding.

Thirty-three insert arrangements per MIL-STD-1669 are tooled and qualified to MIL-DTL-26482 Series 2, utilizing 3 to 61 M39029 contacts. Contacts come in sizes 20, 16 and 12, terminating wire sizes from 24 to 12 gauge.

These connectors are available in wide range of shell materials and finishes. Aluminum shells are offered in electroless nickel, olive drab cadmium and black anodic. Other finishes such as zinc nickel are available upon request to commercial callouts only. In addition, we offer passivated stainless steel shells with standard environment-resisting inserts (commercial callouts only), and for highly corrosive environments, nickel-aluminum-bronze shells with standard environment-resisting inserts (commercial callouts only).

Universal I/R Tool – A single, expendable plastic tool is used for both insertion and removal of contacts.

Insert Polarization – Alternate insert clocking positions aid in mating of adjacent connectors having identical insert arrangement.

Closed-Entry Socket Insert – Hard dielectric socket face has lead-in chamfers for positive alignment of pins (even partially bent within pre-established limits) with sockets.

Interfacial Pin Insert Seal – Raised moisture barriers around each pin, which mate into lead-in chamfers of hard face socket insert, provide individual contact sealing. Interfacial seal is never touched by service tools.

Elastomer Wire Sealing Grommet – Sealing over a wide range of wire diameters is assured by a triple wire seal in each cavity at the rear of the connector.

Superior Contact Stability – Rear release crimp contact system features a stamped beryllium-copper retaining clip captivated by molded-in shoulders of each contact cavity in the insulator. A rear-inserted M81969 plastic tool expands the tines beyond the shoulder, releasing the contact.



Performance Specifications

Operating Temperature Range

Classes A, L and S*: -55°C to +200°C (-67°F to +392°F)
 Classes W and ZC*: -55°C to +175°C (-67°F to +347°F)

Material and Finish Data (Class)

A – aluminum shell, black anodized finish
 L – aluminum shell, electroless nickel finish
 W – aluminum shell, olive drab cadmium over nickel base
 S* – stainless steel shell, passivated
 Z* – aluminum shell, zinc nickel finish

Corrosion Resistance

Classes A, S*, W and ZC* withstand 500-hour salt spray.
 Class L withstands 48-hour salt spray.

Environmental Seal

Wired, mated connectors with specified accessories attached, shall meet the altitude-immersion test specified in MIL-DTL-26482 Series 2.

Fluid Resistance

Connectors resist specified immersions in MIL-PRF-7808 (lubricating oil), MIL-PRF-23699 (lubricating oil), MIL-PRF-5606 (hydraulic fluid), M2-V Chevron oil, Coolanol 25, ASTM D4814 (gasoline), SAE-AMS1424 Type I (defrosting fluid), MIL-DTL-5624 (JP-5), and solvents specified in Method 215 of MIL-STD-202.

* Not on QPL, can be supplied to Aero-Electric P/N only.

Durability

Mated connectors withstand a minimum of 250 mating cycles for RFI plug (MS3475) and 500 cycles for standard plug (MS3476).

Shock and Vibration Requirements

Wired, mated connectors shall not be damaged, coupling ring shall not loosen, and there shall be no interruption of electrical continuity longer than one microsecond when subjected to the following:

Shock

Mated connectors withstand a pulse of approximate half sine wave of 300 G magnitude with duration of three milliseconds applied in each direction of the three major axes.

Vibration

Mated connectors withstand the following vibration levels:

- Random vibration per MIL-STD-202, method 214, test condition II, letter J.

Shielding Effectiveness

RFI attenuation at the specified frequency meets the requirements of MIL-DTL-26482 Series 2.

- RFI shielding effectiveness of mated connectors with RFI backshells is measured in a triaxial radio frequency leakage fixture.

Shell-to-Shell Conductivity

- With RFI spring fingers, the maximum potential drop shall not exceed 5 millivolts.
- Without spring fingers, the maximum potential drop shall not exceed 200 millivolts.

Voltage Rating

Service Rating	Suggested Operating Voltage**		Test Voltage	Test Voltage	Test Voltage	Test Voltage
	(Sea Level)		Sea Level	50,000 Ft.	70,000 Ft.	110,000 Ft.
	AC (RMS)	DC	V RMS	V RMS	V RMS	V RMS
I	600	850	1,500	500	375	200
II	1,000	1,275	2,300	750	500	200

** To be used by designer only as a guide.

Military and Aero-Electric Part Number Development

Mil. Prefix	MS34	70	L	12 -	10	P	W	
Aero Prefix	AE7	70	L	12 -	10	P	W	-340
Shell type								
70 = Narrow flange receptacle								
71 = Cable connecting receptacle								
72 = Wide flange receptacle								
74 = Jam nut receptacle								
75 = RFI grounding plug								
76 = Straight plug								
Class (Material and Finish)								
A = Aluminum shell, black anodized finish (not available in RFI plug)								
L = Aluminum shell, electroless nickel finish								
W = Aluminum shell, olive drab cadmium over electroless nickel base								
S* = Stainless steel shell, passivated (Aero part number only)								
Z* = Aluminum shell, zinc nickel finish (Aero part number only)								
Shell Size								
8, 10, 12, 14, 16, 18, 20, 22 or 24								
Insert Arrangement								
See pages 82 thru 85								
Contact Style								
P = Pin								
S = Socket								
A = Pin connector less pins (with intent to use non-std contact)								
B = Socket connector less sockets (with intent to use non-std contacts)								
Polarization								
N = Normal (not included in part number)								
W, X, Y or Z = Alternate insert polarizations (see pages 82 thru 83 for position availability)								
Modification (applies to Aero part numbers only)								
01 = Less contacts (is not marked on the part)								
340 = Connector kitted with M85049/31-XXX E-nut								
341 = Connector kitted with M85049/52-1-XXX straight clamp								
342 = Connector kitted with M85049/51-1-XXX right angle clamp								
Consult factory for other modifications								

* Not on QPL, can be supplied to Aero part number only. Consult factory for availability.

Note 1: Each connector is furnished with contacts unless ordered less contacts (L/C) as follows: One spare contact for inserts requiring 2 to 26 of each contact and two spares for inserts with 27 or more of each size, and a minimum of one sealing plug up to 15% of the number of contacts. In addition, one plastic insetion/removal tool of each size is included.

Note 2: Proper part number marking has no "0" in front of single digit shell size (8) and no "0" after the dash between shell size and single digit layout. Example of each: J MS3470W8-33P and J MS3470W10-6P. In both "N" for normal was omitted. As indicated above, "J" or "JAN" must be marked in front of MIL part number.

Note 3: Insert layouts 8-2, 8-3 and 8-4 can only be ordered to Aero-Electric part number. Non standard contacts are required and to avoid confusion are sold "with contacts" only. See page 80 for the correct contact part numbers.

MS3470

Narrow Flange Receptacle

AE770



Bayonet Coupling, Crimp Removable, Rear Release

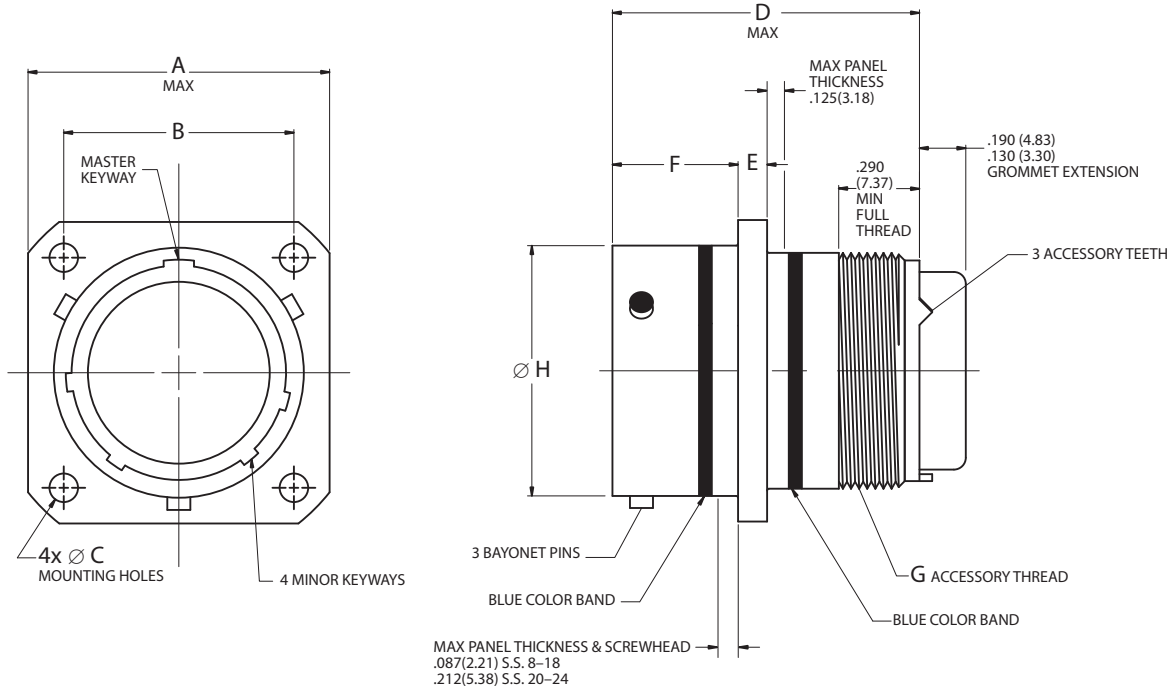

- Page 71 Completed Part Number
- Page 80 Contacts, Sealing Plugs and Tools
- Pages 84, 85 Insert Arrangements
- Page 70 Performance Specifications
- Pages 82, 83 Insert Availability and Contact Information
- Page 82 Polarization

Note: Maximum grommet O.D. is same as Ø C MAX on page 74.

Shell Size	A		B		Ø C		D		E		F		G	Ø H	
	Maximum		(TP)		±.005	±.13	Maximum		±.016	±.41	+0.016	+0.41	Accessory Thread Class 2A	±.003	±.08
	inch	mm	inch	mm	inch	mm	inch	mm	inch	mm	inch	mm		inch	mm
8	.828	21.03	.594	15.09	.120	3.05	1.215	30.86	.062	1.57	.446	11.33	1/2-20UNF	.471	11.96
10	.954	24.23	.719	18.26	.120	3.05	1.215	30.86	.062	1.57	.446	11.33	5/8-24UNEF	.588	14.94
12	1.047	26.59	.812	20.62	.120	3.05	1.215	30.86	.062	1.57	.446	11.33	3/4-20UNEF	.748	19.00
14	1.141	28.98	.906	23.01	.120	3.05	1.215	30.86	.062	1.57	.446	11.33	7/8-20UNEF	.873	22.17
16	1.234	31.34	.969	24.61	.120	3.05	1.215	30.86	.062	1.57	.446	11.33	1-20UNEF	.998	25.35
18	1.328	33.73	1.062	26.97	.120	3.05	1.215	30.86	.062	1.57	.446	11.33	1-1/16-18UNEF	1.123	28.52
20	1.453	36.91	1.156	29.36	.120	3.05	1.275	32.39	.094	2.39	.571	14.50	1-3/16-18UNEF	1.248	31.70
22	1.578	40.08	1.250	31.75	.120	3.05	1.275	32.39	.094	2.39	.571	14.50	1-5/16-18UNEF	1.373	34.87
24	1.703	43.26	1.375	34.93	.147	3.73	1.275	32.39	.094	2.39	.604	15.34	1-7/16-18UNEF	1.498	38.05

Bayonet Coupling, Crimp Removable, Rear Release

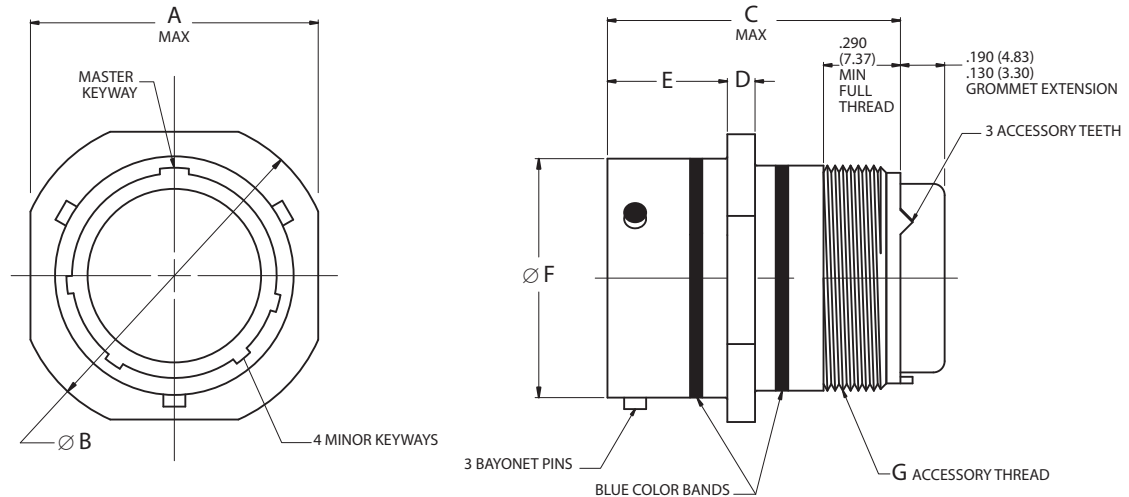

Page 71	Completed Part Number
Page 80	Contacts, Sealing Plugs and Tools
Pages 84, 85	Insert Arrangements
Page 70	Performance Specifications
Pages 82, 83	Insert Availability and Contact Information
Page 82	Polarization

Note: Maximum grommet O.D. is same as \varnothing C MAX on page 74.

Shell Size	A		\varnothing B		C		D		E		\varnothing F		G
	Maximum		± 0.020	± 0.51	Maximum		± 0.016	± 0.41	$+0.016$	$+0.41$	± 0.003	± 0.08	Accessory Thread Class 2A
	inch	mm	inch	mm	inch	mm	inch	mm	inch	mm	inch	mm	
8	.828	21.03	.938	23.83	1.215	30.86	.062	1.57	.446	11.33	.471	11.96	1/2-20UNF
10	.954	24.23	1.062	26.97	1.215	30.86	.062	1.57	.446	11.33	.588	14.94	5/8-24UNEF
12	1.047	26.59	1.156	29.36	1.215	30.86	.062	1.57	.446	11.33	.748	19.00	3/4-20UNEF
14	1.141	28.98	1.250	31.75	1.215	30.86	.062	1.57	.446	11.33	.873	22.17	7/8-20UNEF
16	1.234	31.34	1.344	34.14	1.215	30.86	.062	1.57	.446	11.33	.998	25.35	1-20UNEF
18	1.328	33.73	1.438	36.53	1.215	30.86	.062	1.57	.446	11.33	1.123	28.52	1-1/16-18UNEF
20	1.453	36.91	1.562	39.67	1.275	32.39	.094	2.39	.571	14.50	1.248	31.70	1-3/16-18UNEF
22	1.578	40.08	1.688	42.88	1.275	32.39	.094	2.39	.571	14.50	1.373	34.87	1-5/16-18UNEF
24	1.703	43.26	1.812	46.02	1.275	32.39	.094	2.39	.604	15.34	1.498	38.05	1-7/16-18UNEF

MS3472

Wide Flange Receptacle

AE772



Bayonet Coupling, Crimp Removable, Rear Release

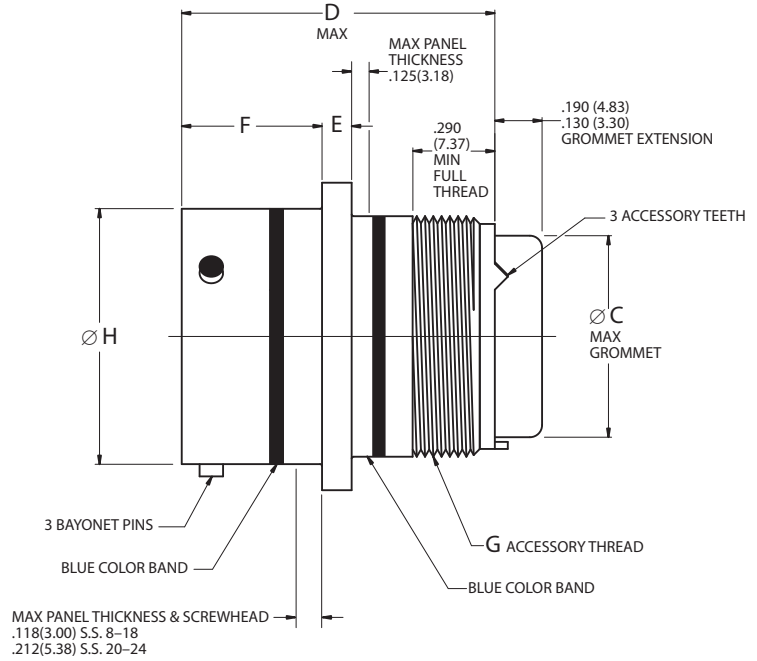
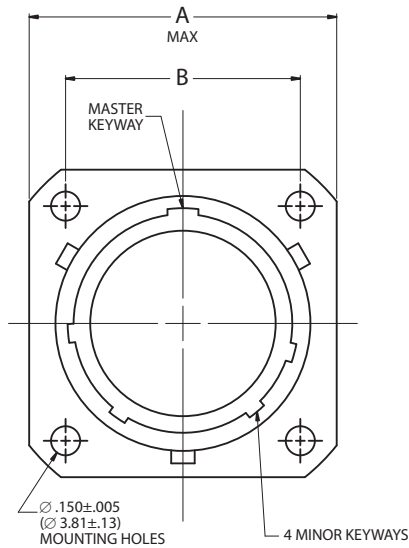

MIL-DTL-26482 S 2

- Page 71 Completed Part Number
- Page 80 Contacts, Sealing Plugs and Tools
- Pages 84, 85 Insert Arrangements
- Page 70 Performance Specifications
- Pages 82, 83 Insert Availability and Contact Information
- Page 82 Polarization

Shell Size	A		B		\varnothing C		D		E		F		G	\varnothing H	
	Maximum		(TP)		Maximum		Maximum		$\pm .016$	$\pm .41$	$+ .016$	$+ .41$	Accessory Thread Class 2A	$\pm .003$	$\pm .08$
	inch	mm	inch	mm	inch	mm	inch	mm	inch	mm	inch	mm		inch	mm
8	1.065	27.05	.734	18.64	.305	7.75	1.215	30.86	.062	1.57	.477	12.12	1/2-20UNF	.471	11.96
10	1.141	28.98	.812	20.62	.405	10.29	1.215	30.86	.062	1.57	.477	12.12	5/8-24UNEF	.588	14.94
12	1.266	32.16	.938	23.83	.531	13.49	1.215	30.86	.062	1.57	.477	12.12	3/4-20UNEF	.748	19.00
14	1.360	34.54	1.031	26.19	.665	16.89	1.215	30.86	.062	1.57	.477	12.12	7/8-20UNEF	.873	22.17
16	1.453	36.91	1.125	28.58	.790	20.07	1.215	30.86	.062	1.57	.477	12.12	1-20UNEF	.998	25.35
18	1.532	38.91	1.203	30.56	.869	22.07	1.215	30.86	.062	1.57	.477	12.12	1-1/16-18UNEF	1.123	28.52
20	1.688	42.88	1.297	32.94	.994	25.25	1.275	32.39	.094	2.39	.571	14.50	1-3/16-18UNEF	1.248	31.70
22	1.766	44.86	1.375	34.93	1.119	28.42	1.275	32.39	.094	2.39	.571	14.50	1-5/16-18UNEF	1.373	34.87
24	1.891	48.03	1.500	38.10	1.244	31.60	1.275	32.39	.094	2.39	.604	15.34	1-7/16-18UNEF	1.498	38.05

Bayonet Coupling, Crimp Removable, Rear Release

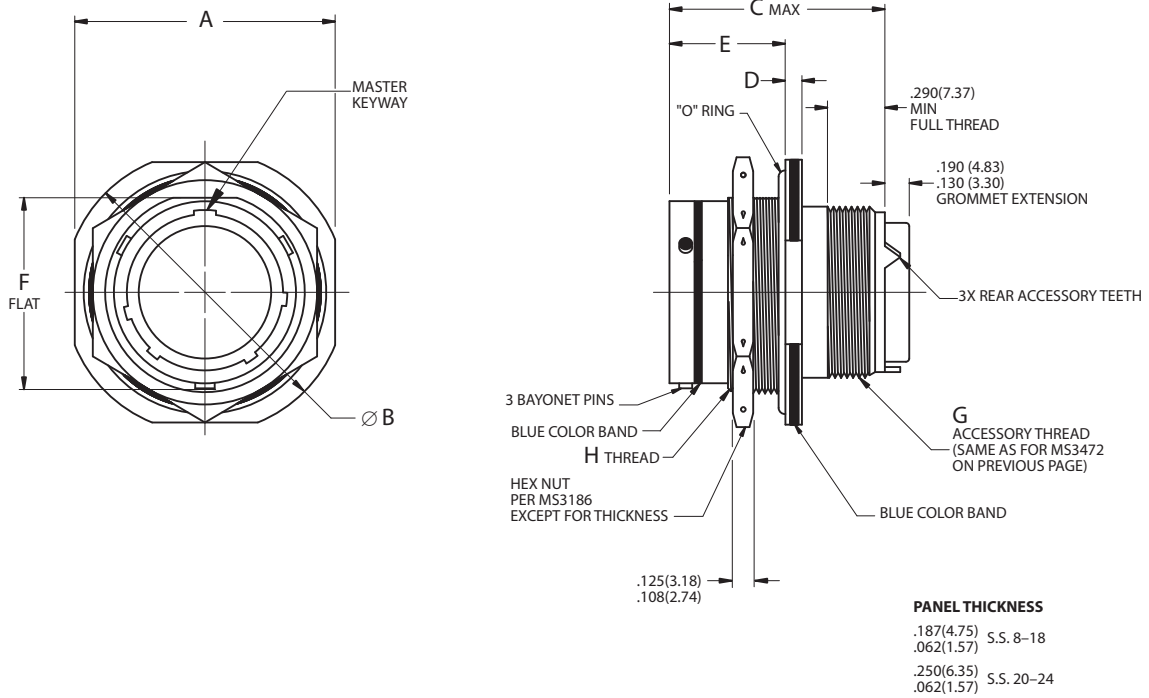

Page 71 Completed Part Number
 Page 80 Contacts, Sealing Plugs and Tools
 Pages 84, 85 Insert Arrangements
 Page 70 Performance Specifications
 Pages 82, 83 Insert Availability and Contact Information
 Page 82 Polarization

Note: Maximum grommet O.D. is same as Ø E MAX on page 76.

Shell Size	A		Ø B		C		D		E		F		H
	+0.00	+0.00	+0.00	+0.00	Maximum						Flat		Jam Nut Thread
	-0.031	-0.79	-0.031	-0.79							±.005	±.13	
	inch	mm	inch	mm	inch	mm	inch	mm	inch	mm	inch	mm	UNEF-2A
8	.954	24.23	1.078	27.38	1.215	30.86	.113/.086	2.87/2.18	.707/.658	17.96/16.71	.525	13.34	9/16-24
10	1.078	27.38	1.203	30.56	1.215	30.86	.113/.086	2.87/2.18	.707/.658	17.96/16.71	.650	16.51	11/16-24
12	1.266	32.16	1.391	35.33	1.215	30.86	.113/.086	2.87/2.18	.707/.658	17.96/16.71	.813	20.65	7/8-20
14	1.391	35.33	1.516	38.51	1.215	30.86	.113/.086	2.87/2.18	.707/.658	17.96/16.71	.937	23.80	1-20
16	1.516	38.51	1.641	41.68	1.215	30.86	.113/.086	2.87/2.18	.707/.658	17.96/16.71	1.061	26.95	1-1/8-18
18	1.641	41.68	1.766	44.86	1.215	30.86	.113/.086	2.87/2.18	.707/.658	17.96/16.71	1.186	30.12	1-1/4-18
20	1.828	46.43	1.954	49.63	1.275	32.39	.148/.096	3.76/2.44	.772/.721	19.61/18.31	1.311	33.30	1-3/8-18
22	1.954	49.63	2.078	52.78	1.275	32.39	.148/.096	3.76/2.44	.772/.721	19.61/18.31	1.436	36.47	1-1/2-18
24	2.078	52.78	2.203	55.96	1.275	32.39	.148/.096	3.76/2.44	.772/.721	19.61/18.31	1.561	39.65	1-5/8-18

MS3476
Straight Plug
AE776



Bayonet Coupling, Crimp Removable, Rear Release

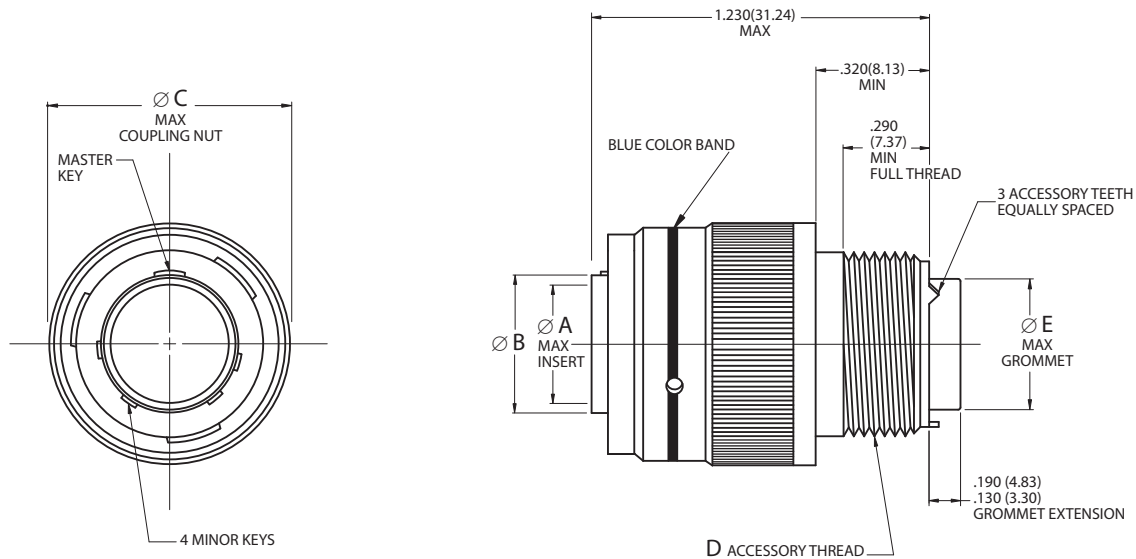

Page 71	Completed Part Number
Page 80	Contacts, Sealing Plugs and Tools
Pages 84, 85	Insert Arrangements
Page 70	Performance Specifications
Pages 82, 83	Insert Availability and Contact Information
Page 82	Polarization

MIL-DTL-26482 S 2

Shell Size	Ø A		Ø B		Ø C		D	Ø E	
	Maximum		±.003	±.08	Maximum			Accessory Thread Class 2A	Maximum
	inch	mm	inch	mm	inch	mm		inch	mm
8	.285	7.24	.355	9.02	.782	19.86	1/2-20UNF	.305	7.75
10	.402	10.21	.483	12.27	.926	23.52	5/8-24UNEF	.405	10.29
12	.516	13.11	.595	15.11	1.043	26.49	3/4-20UNEF	.531	13.49
14	.641	16.28	.720	18.29	1.183	30.05	7/8-20UNEF	.665	16.89
16	.766	19.46	.845	21.46	1.305	33.15	1-20UNEF	.790	20.07
18	.855	21.72	.945	24.00	1.391	35.33	1-1/16-18UNEF	.869	22.07
20	.980	24.89	1.070	27.18	1.531	38.89	1-3/16-18UNEF	.994	25.25
22	1.105	28.07	1.195	30.35	1.656	42.06	1-5/16-18UNEF	1.119	28.42
24	1.229	31.22	1.320	33.53	1.777	45.14	1-7/16-18UNEF	1.244	31.60

Bayonet Coupling, Crimp Removable, Rear Release

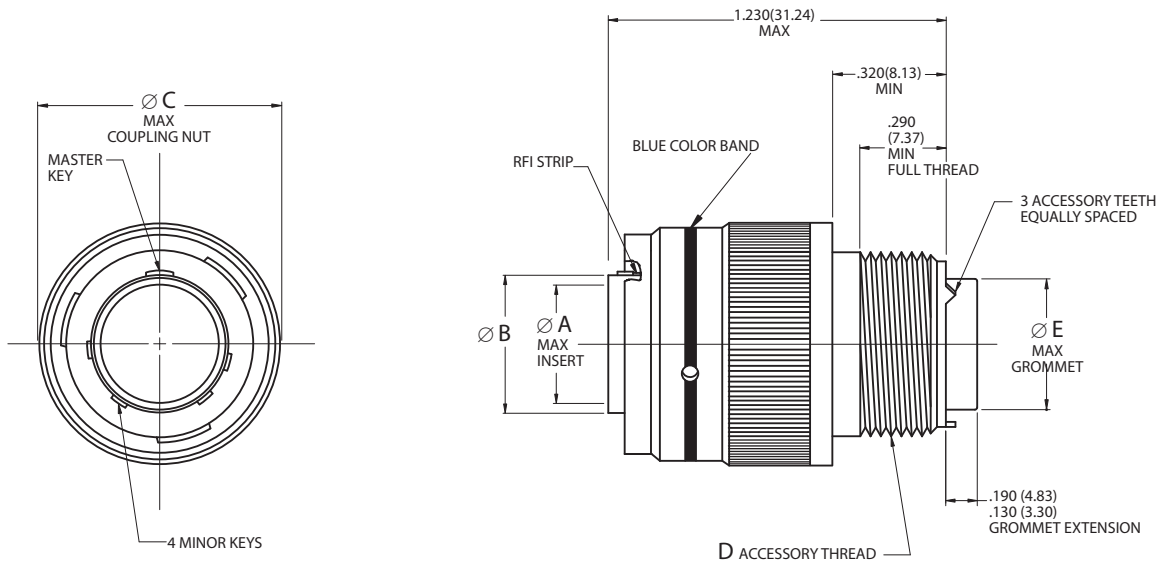

Page 71	Completed Part Number
Page 80	Contacts, Sealing Plugs and Tools
Pages 84, 85	Insert Arrangements
Page 70	Performance Specifications
Pages 82, 83	Insert Availability and Contact Information
Page 82	Polarization

Shell Size	$\varnothing A$		$\varnothing B$		$\varnothing C$		D	$\varnothing E$	
	Maximum		$\pm .003$	$\pm .08$	Maximum		Accessory Thread Class 2A	Maximum	
	inch	mm	inch	mm	inch	mm		inch	mm
8	.285	7.24	.355	9.02	.782	19.86	1/2-20UNF	.305	7.75
10	.402	10.21	.483	12.27	.926	23.52	5/8-24UNEF	.405	10.29
12	.516	13.11	.595	15.11	1.043	26.49	3/4-20UNEF	.531	13.49
14	.641	16.28	.720	18.29	1.183	30.05	7/8-20UNEF	.665	16.89
16	.766	19.46	.845	21.46	1.305	33.15	1-20UNEF	.790	20.07
18	.855	21.72	.945	24.00	1.391	35.33	1-1/16-18UNEF	.869	22.07
20	.980	24.89	1.070	27.18	1.531	38.89	1-3/16-18UNEF	.994	25.25
22	1.105	28.07	1.195	30.35	1.656	42.06	1-5/16-18UNEF	1.119	28.42
24	1.229	31.22	1.320	33.53	1.777	45.14	1-7/16-18UNEF	1.244	31.60

AC3475 Arctic Coupling Nut, RFI Plug



Bayonet Coupling, Crimp Removable, Rear Release

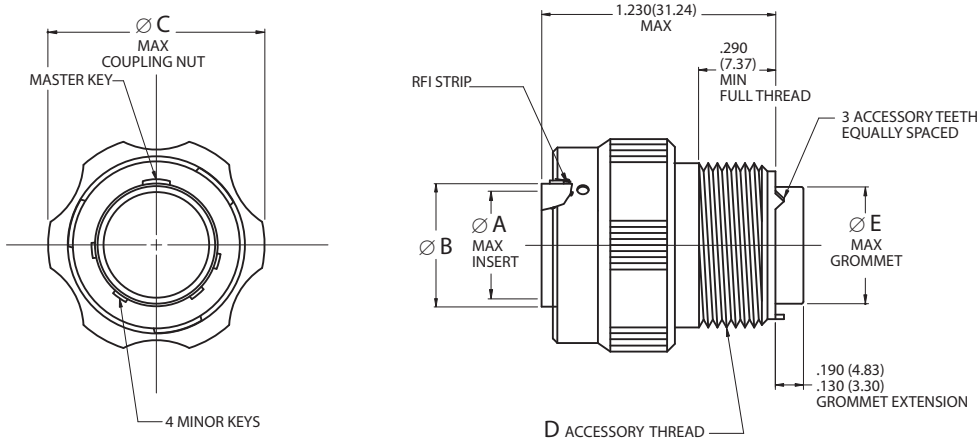

AC3475 - **10-** **7** **P** **N**

Aero Prefix ————— **AC3475**

Class (Material and Finish) ————— **-**
 - = Aluminum shell, cadmium olive drab over nickel
 Z = Aluminum shell, zinc nickel finish

Shell Size ————— **10-**
8, 10, 12, 14, 16, 18, 20, 22 or **24**

Polarization ————— **N**
N = Normal (N included in part number marking)
A, B, C, D, E or **F** (Alternate key positions)
W, X, Y or **Z** (Alternate insert clocking positions)

Contact Style ————— **P** = Pin
S = Socket

Layout ————— **N**

See pages 82 thru 85

Page 80 Contacts, Sealing Plugs and Tools
 Pages 84, 85 Insert Arrangements
 Page 70 Performance Specifications
 Pages 82, 83 Insert Availability and Contact Information
 Page 82 Polarization

Note: AC3475 Arctic Coupling Nut, RFI Plug is available to Aero-Electric part number only. Mating part is AC3474 which is same as AE774 on page 75. Additional mates are AC3470 (same as AE770 on page 72), AC3471 (same as AE771 on page 73) and AC3472 (same as AE772 on page 74).

Shell Size	Ø A		Ø B		Ø C		D	Ø E	
	Maximum		±.003	±.08	Maximum		Accessory Thread Class 2A	Maximum	
	inch	mm	inch	mm	inch	mm		inch	mm
8	.285	7.24	.355	9.02	.900	22.86	1/2-20UNF	.305	7.75
10	.402	10.21	.483	12.27	1.010	25.65	5/8-24UNEF	.405	10.29
12	.516	13.11	.595	15.11	1.180	29.97	3/4-20UNEF	.531	13.49
14	.641	16.28	.720	18.29	1.310	33.27	7/8-20UNEF	.665	16.89
16	.766	19.46	.845	21.46	1.510	38.35	1-20UNEF	.790	20.07
18	.855	21.72	.945	24.00	1.620	41.15	1-1/16-18UNEF	.869	22.07
20	.980	24.89	1.070	27.18	1.740	44.20	1-3/16-18UNEF	.994	25.25
22	1.105	28.07	1.195	30.35	1.850	46.99	1-5/16-18UNEF	1.119	28.42
24	1.229	31.22	1.320	33.53	1.980	50.29	1-7/16-18UNEF	1.244	31.60

Panel Cutouts

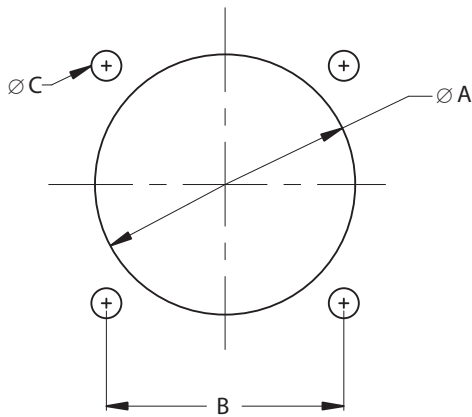

MS3470(AE770)

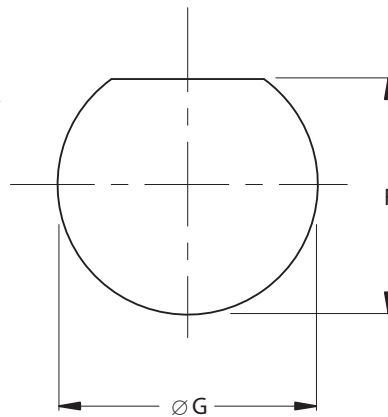

MS3474(AE774)

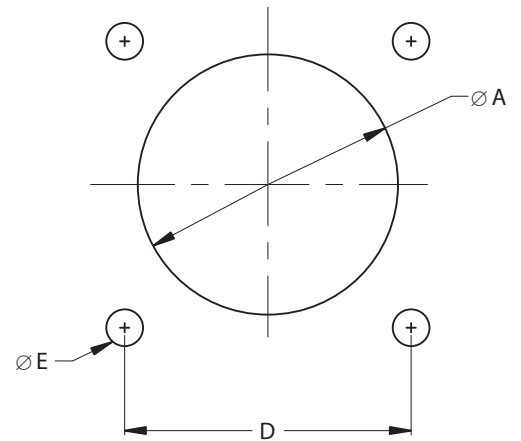

MS3472(AE772)

Flange and Jam Nut Mounting Dimensions

Shell Size	Ø A		B		Ø C		D		Ø E		F		Ø G	
	±.005 inch	±.13 mm	(TP)		±.010 inch	±.25 mm	(TP)		±.010 inch	±.25 mm	±.005 inch	±.13 mm	±.005 inch	±.13 mm
8	.568	14.43	.594	15.09	.120	3.05	.734	18.64	.150	3.81	.536	13.61	.572	14.53
10	.685	17.40	.719	18.26	.120	3.05	.812	20.62	.150	3.81	.661	16.79	.697	17.70
12	.864	21.95	.812	20.62	.120	3.05	.938	23.83	.150	3.81	.824	20.93	.895	22.73
14	.989	25.12	.906	23.01	.120	3.05	1.031	26.19	.150	3.81	.948	24.08	1.010	25.65
16	1.113	28.27	.969	24.61	.120	3.05	1.125	28.58	.150	3.81	1.072	27.23	1.135	28.83
18	1.238	31.45	1.062	26.97	.120	3.05	1.203	30.56	.150	3.81	1.197	30.40	1.260	32.00
20	1.363	34.62	1.156	29.36	.120	3.05	1.297	32.94	.150	3.81	1.322	33.58	1.385	35.18
22	1.488	37.80	1.250	31.75	.120	3.05	1.375	34.93	.150	3.81	1.447	36.75	1.510	38.35
24	1.615	41.02	1.375	34.93	.147	3.73	1.500	38.10	.150	3.81	1.572	39.93	1.635	41.53

Note: For Ø C and Ø E, MS3470 and MS3472 call out for tolerance of ±.010 (±.25), however we recommend ±.005 (±.13).

MIL-DTL-26482

Contacts, Tools and Seal Plugs Series 2



Contacts, Plastic Insertion/Removal Tools and Seal Plugs

Contact Size	Application	Pin Contacts	Socket Contacts	Seal Plugs	Insertion/Removal Tools
	Type	Military No.	Military No.	Military No.	Military No.
20	Power/Signal	M39029/4-110	M39029/5-115	MS27488-20-1	M81969/14-11
16	Power/Signal	M39029/4-111	M39029/5-116	MS27488-16-1	M81969/14-03
12	Power/Signal	M39029/4-113	M39029/5-118	MS27488-12-1	M81969/14-04
20*	Power/Signal	5291-022-204H	5091-022-204H	MS27488-20-1	M81969/39-01

* Size 20 contacts for 8-2, 8-3 and 8-4 layouts are only available to Aero-Electric part numbers. Connectors incorporating these three layouts are only sold to Aero-Electric callouts (AE770, AE771, AE772, AE774, AE775, AE776, AC3470, AC3471, AC3472, AC3474 and AC3475). Standard size 20 contacts M39029/4-110 and M39029/5-115 will not work in these 3 layouts.

Crimping and Metal Insertion/Extraction Tools

Contact Size	Crimp Tool	Positioner	Positioner	Insertion Tool	Extraction Tool
	Military No.	For Pin Contacts Military No.	For Socket Contacts Military No.	Metal Military No.	Metal Military No.
20	M22520/1-01	M22520/1-02	M22520/1-02	M81969/8-205	M81969/8-206
	M22520/2-01	M22520/2-02	M22520/2-02		
16	M22520/1-01	M22520/1-02	M22520/1-02	M81969/8-207	M81969/8-208
12	M22520/1-01	M22520/1-02	M22520/1-02	M81969/8-209	M81969/8-210
20*	M22520/1-01	M22520/1-02	M22520/1-02	M81969/8-205	M81969/8-206
	M22520/2-01	M22520/2-02	M22520/2-02		

Contact and Wire Data

Contact Size	Test Current	Voltage	Crimp Well Data			Wire Range		Finished Wire Ø Range			
	DC Test Amps	Max. Drop Millivolts	Well Dia. inch	Minimum Well Dept inch mm		AWG	mm ²	Minimum inch mm		Maximum inch mm	
20	7.5	55	.049 ±.001	.155	3.94	24-20	.20-.52	.040	1.02	.083	2.11
16	13.0	49	.067 ±.001	.250	6.35	20-16	.52-1.31	.053	1.35	.103	2.62
12	23.0	42	.100 ±.002	.250	6.35	14-12	2.08-3.31	.097	2.46	.158	4.01

Note: Test Current and Maximum Voltage Drop when tested with silver-plated wire at 25°C.



Contact Installation Instructions

Crimping Contacts

1. Select the appropriate crimp tool and ensure that the proper crimp head positioner is used.
2. Cycle the tool to be sure the indentors are open.
3. Determine the correct selector setting for the wire size from the data plate on the positioner (turret head assembly) and set the selector knob on the crimp tool to match.
4. Place the contact, mating end first, into the tool.
5. Insert the stripped wire into the hollow end of the contact. Be sure the wire is inserted as far as it will go.
6. Close the tool completely to crimp. Unless the tool is closed completely, the tool will not release the contact.
7. Remove the crimped contact from the tool. Check the inspection hole to verify that the wire is fully inserted.

Insertion of Contacts

1. Before inserting the contacts, unscrew the accessories (clamps, backshells or adapters) from rear of plug or receptacle. Slide the hardware over the wire bundle in the proper order for reassembly after all the contacts are inserted.
2. To assist insertion of contacts, lubricate insulator (grommet) cavities with isopropyl alcohol. Alcohol will evaporate and will not leave a conductive film. **Caution: Never use any lubricant other than isopropyl alcohol.**

3. Place the correct insertion tool on the contact so that the wire runs along the groove in the tool. (Tool tip will butt against the shoulder.) Hold the plug or receptacle body firmly.
4. Beginning with a center cavity, insert the contact into the insulator with a slow, even pressure until the contact snaps into position. Make sure the contact and tool are held perpendicular to the face of the insert during the contact installation or the grommet could be damaged.
 - 4.1 If contacts are not inserted all the way prior to removing insertion tool, do not try to reinsert the insertion tool. Instead, remove the contact and try again; otherwise reinserting the insertion tool may damage the inside of the contact cavity.
5. Remove tool and check the face of the connector for proper contact installation. Proper installation may also be checked by pulling back lightly on the wire to make sure the contact is properly seated.

Completion

After all the cavities have been filled, slide the hardware back into position on the connector and tighten.

Extraction of Contacts (Rework)

1. Slide the hardware back over the wire bundle.
2. Select the appropriate tool. Place the wire into the extraction tool of the pin or socket.
3. Slowly slide the extraction tool down wire into the contact cavities until the tool tip bottoms against the contact shoulder, expanding the clip retaining tines. Hold the wire firmly in the tool and pull the wired contact and tool straight out of the rear of the insulator.

Size	Pin Contact	Socket Contact	Basic Crimp Tool	Pin Positioner	Socket Positioner	Insertion/Removal Tool
20	M39029/4-110	M39029/5-115	M22520/1-01	M22520/1-02 Red	M22520/1-02 Red	M81969/14-11
			M22520/2-01	M22520/2-02	M22520/2-02	
16	M39029/4-111	M39029/5-116	M22520/1-01	M22520/1-02 Blue	M22520/1-02 Blue	M81969/14-03
12	M39029/4-113	M39029/5-118	M22520/1-01	M22520/1-02 Yellow	M22520/1-02 Yellow	M81969/14-04
20*	5291-022-204H	5091-022-204H	M22520/1-01	M22520/1-02 Red	M22520/1-02 Red	M81969/39-01
			M22520/2-01	SK2/2**	SK2/2**	

* Aero-Electric proprietary size 20 contacts used in 8-2, 8-3 and 8-4 layouts only.

** Daniels Manufacturing part number.

MIL-DTL-26482 Series 2

Polarization, Insert Availability & Contact Information

per MIL-STD-1669



Polarization (Insert Clocking)

1. In the normal insert clocking position (position N), the insert centerline coincides with the centerline of the master keyway (key) of the shell: $L = 0^\circ$.
2. In the alternate clocking positions (W, X, Y and Z), the pin insert (viewing from mating side) is rotated clockwise relative to the centerline of the master keyway (key) of the shell.
3. The socket insert is rotated counter-clockwise.
4. Plugs have keys; receptacles have keyways.

Note: Be careful with alternate positions. See table below for position availability on layouts of interest.

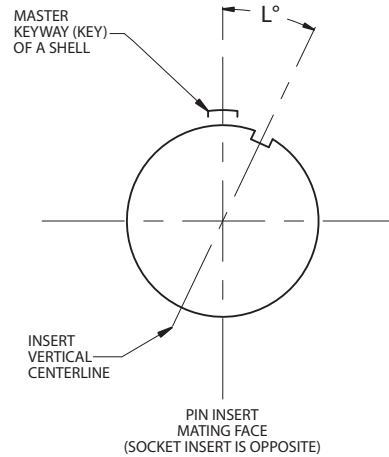

Insert Availability, Contact Information and Clocking Positions

Insert Arrangement	Aero-Electric		Total	Contact Quantity			Service	Insert Positions				
	Status		No. of	By Size			Rating	In Degrees				
	QPL'd	Tooled	Contacts	20	16	12		N	W	X	Y	Z
8-2*	No	Yes	2	2			I	0	58	122	—	—
8-3*	No	Yes	3	3			I	0	60	210	—	—
8-4*	No	Yes	4	4			I	0	45	—	—	—
8-33	Yes	Yes	3	3			I	0	90	—	—	—
8-98	Yes	Yes	3	3			I	0	—	—	—	—
10-6	Yes	Yes	6	6			I	0	90	—	—	—
10-7**	N/A	Yes	7	7			I	0	90	—	—	—
12-3	Yes	Yes	3		3		II	0	—	—	180	—
12-8	Yes	Yes	8	8			I	0	90	112	203	292
12-10	Yes	Yes	10	10			I	0	60	155	270	295
14-2**	N/A	Yes	2			2	I	0	—	—	—	—
14-4	Yes	Yes	4			4	I	0	45	—	—	—
14-5	Yes	Yes	5		5		II	0	40	92	184	273
14-9	Yes	Yes	9	5		4	I	0	15	90	180	240
14-12	Yes	Yes	12	8	4		I	0	43	90	—	—
14-15	Yes	Yes	15	14	1		I	0	17	110	155	234
14-18	Yes	Yes	18	18			I	0	15	90	180	270
14-19	Yes	Yes	19	19			I	0	30	165	315	—

* Not qualified to MIL-DTL-26482 Series 2. These layouts were designed to mate with solder Series 1 connectors using proprietary Aero-Electric contacts (not QPL'd to M39029) and to avoid confusion are sold only "with contacts".

** Non MIL-STD-1669 layouts, available to Aero-Electric part numbers only and utilize standard M39029 contacts. These layouts were originally designed for use in AC3475 Arctic Coupling RFI plugs and AC3474 jam nut receptacles.



MIL-DTL-26482 Series 2
Polarization, Insert Availability & Contact Information
per MIL-STD-1669

Insert Availability, Contact Information and Clocking Positions

Insert Arrangement	Aero-Electric		Total	Contact Quantity			Service	Insert Positions				
	Status		No. of	By Size			Rating	In Degrees				
	QPL'd	Tooled	Contacts	20	16	12		N	W	X	Y	Z
16-8	Yes	Yes	8		8		II	0	54	152	180	331
16-14	Yes	Yes	14	8		6	I	0	25	78	180	240
16-23	Yes	Yes	23	22	1		I	0	158	270	—	—
16-26	Yes	Yes	26	26			I	0	60	—	275	338
18-8	Yes	Yes	8			8	I	0	180	—	—	—
18-11	Yes	Yes	11		11		II	0	62	119	241	340
18-30	Yes	Yes	30	29	1		I	0	180	193	285	350
18-32	Yes	Yes	32	32			I	0	85	138	222	265
20-16	Yes	Yes	16		16		II	0	238	318	333	347
20-24	Yes	Yes	24	24			I	0	70	145	215	290
20-39	Yes	Yes	39	37	2		I	0	63	144	252	333
20-41	Yes	Yes	41	41			I	0	45	126	225	—
22-12	Yes	Yes	12			12	I	0	—	—	—	—
22-21	Yes	Yes	21		21		II	0	16	135	175	349
22-41	Yes	Yes	41	27	14		I	0	39	135	264	—
22-55	Yes	Yes	55	55			I	0	30	142	226	314
22-95	Yes	Yes	32	26		6	I	0	26	180	266	—
24-19	Yes	No	19			19	II	0	30	165	315	—
24-31	Yes	Yes	31		31		I	0	90	225	255	—
24-61	Yes	Yes	61	61			I	0	90	180	270	324

MIL-DTL-26482 S 2

MIL-STD-1669

Insert Arrangements (Pin Front View) for MIL-DTL-26482 Series 2 Connectors



Insert Arrangement Views



8-2*
2 # 20, I



8-3*
3 # 20, I



8-4*
4 # 20, I



8-33
3 # 20, I



8-98
3 # 20, I

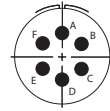

10-6
6 # 20, I

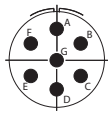

10-7**
7 # 20, I

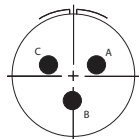

12-3
3 # 16, II

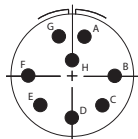

12-8
8 # 20, I

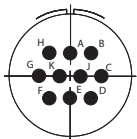

12-10
10 # 20, I

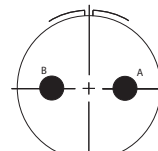

14-2**
2 # 12, I

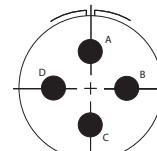

14-4
4 # 12, I

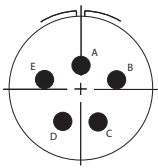

14-5
5 # 16, II

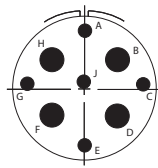

14-9
5 # 20, 4 # 12, I

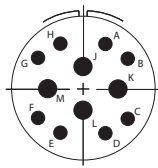

14-12
4 # 16, 8 # 20, I

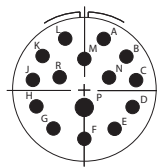

14-15
1 # 16, 14 # 20, I

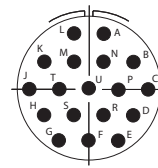

14-18
18 # 20, I

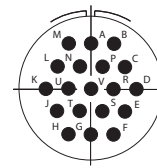

14-19
19 # 20, I

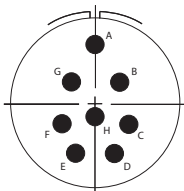

16-8
8 # 16, II

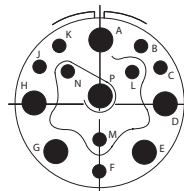

16-14
8 # 20, 6 # 12, I

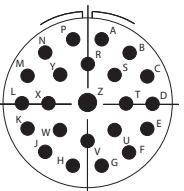

16-23
1 # 16, 22 # 20, I

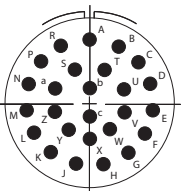

16-26
26 # 20, I

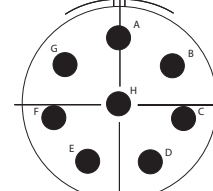

18-8
8 # 12, I

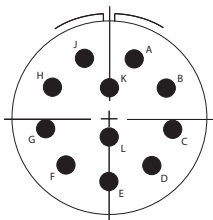

18-11
11 # 16, II

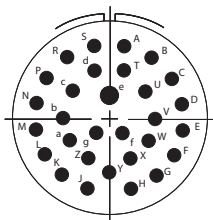

18-30
1 # 16, 29 # 20, I

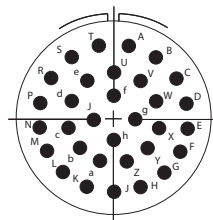

18-32
32 # 20, I

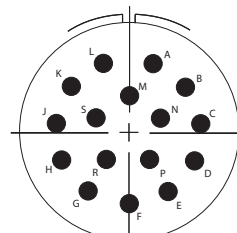

20-16
16 # 16, II

* Not on QPL, available to Aero-Electric part number only.

** Non MIL-STD-1669 layout, available in AC3470 through AC3475 shell styles only.

Insert Arrangement Views

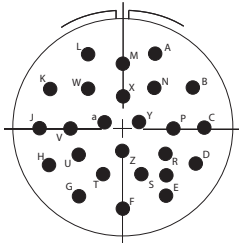

20-24
24 # 20, I

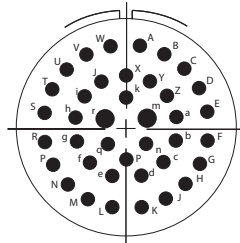

20-39
2 # 16, 37 # 20, I

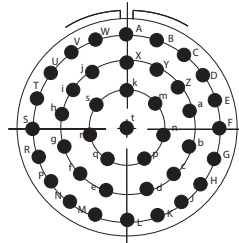

20-41
41 # 20, I

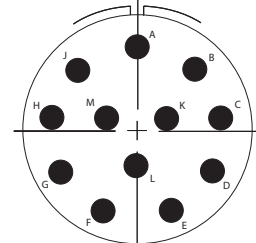

22-12
12 # 12, I

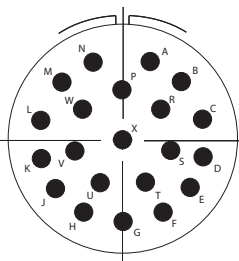

22-21
21 # 16, II

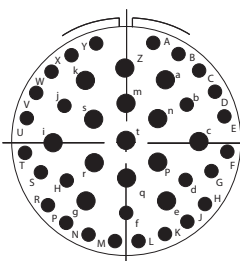

22-41
14 # 16, 27 # 20, I

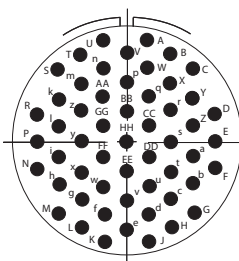

22-55
55 # 20, I

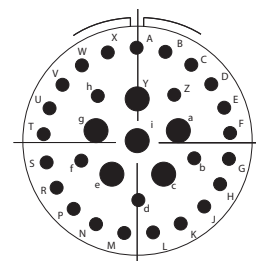

22-95
6 # 12, 26 # 20, I

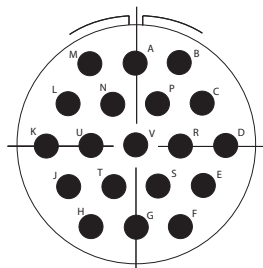

24-19
19 # 12, II

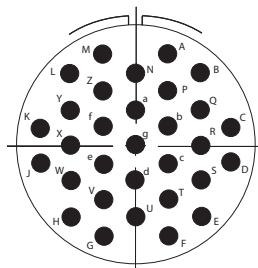

24-31
31 # 16, I

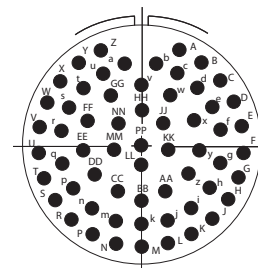

24-61
61 # 20, I